

Staufix FKA automatic backwater valve DN 100, Floor slab, tileable

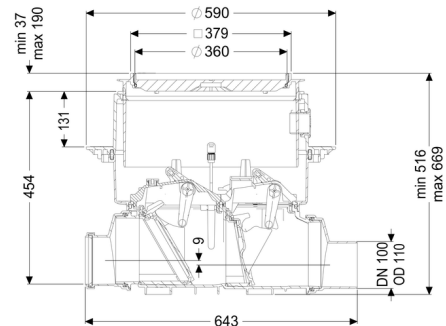
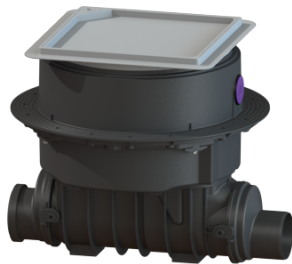

Article information

Item no.: 84100X
 GTIN: 4026092046449
 Price group: 30

Advantages

- Safe, motor-driven closure system with optical probe
- Fast, simple and toolless maintenance
- Available as a complete set or module set

Description

The Premium automatic backwater valve for faecal and faecal-free wastewater is equipped with a motor-driven closure system which is closed automatically in the event of backwater. A second closure system serves as an emergency closure to be closed by hand.

The station is controlled by a user-friendly control unit, which is optionally integrated in the building management system via a potential-free contact, or alarm and collective fault messages can be output via a GSM interface.

Thanks to the modular KESSEL system, existing systems can easily be converted to a Pumpfix F backwater pumping station.

Type of wastewater: wastewater with sewage
 Installation situation: floor slab installation

Version:

Type of waterproofing layer: Waterproofing layer
 Emergency closure: yes

Delivery state: Pre-mounted for final assembly on site (sensor system must be fitted on site and control unit must be connected)

Backwater protection: Type 3

Number of mechanical backwater flaps:	1
Number of motor-driven backwater flaps:	1

General characteristics:

Nominal size (DN):	100
Outer diameter (OD):	110
Colour:	black
Standard:	EN 13564

Dimensions:

Length:	642 mm
Width:	590 mm
Cutout dimension, length:	750 mm
Cutout dimension, width:	750 mm

Tank:

Installation depth:	486 - 640 mm
Groundwater resistant from lower edge of base section:	3,000 mm

Drain body:

Socket version:	including spigot and socket
Vertical adjustment:	vertically adjustable upper section

Coverage features:

Type of cover:	tileable cover plate
Cover material:	Polymer
Max. flooring height:	16 mm
Load class:	K 3 (EN 1253-1)
Length:	366 mm
Width:	366 mm
Tightness:	surface water resistant
Locking:	Lock & Lift
Vertical drop between inlet and outlet:	9 mm
Cable length:	5 m
Motor type:	KSM 140
Protection class motor:	IP 68 (3m/48h)
Protection class probe:	IP 68 (3m/48h)

Control:

Control unit:	Comfort
Operating voltage:	230 V
Mains frequency:	50 Hz
Self-diagnosis system (SDS):	yes
Battery buffering:	yes
Multi-line display:	yes
Log book function:	yes
USB interface:	yes
GSM interface:	yes
Potential-free contact:	optional
Protection class control unit:	IP 54
Length of mains cable for control unit:	1.4 m
Type of level measurement:	optical
Level measurement instrument:	optical probe
Alarm sensor:	optical probe