

KESSEL Controlfix backwater technical module DN 125, closed channel passage

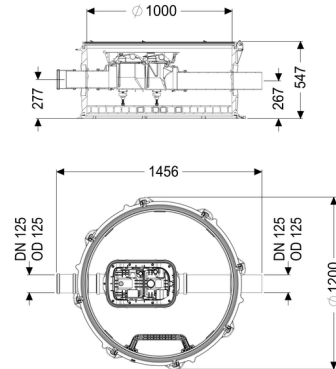

Article information

Item no.: 851251
 GTIN: 4026092079379
 Price group: 60

Advantages

- Komfort: expensive living or useful space is not lost
- No system noises or unpleasant odours and soiling in the building
- Straightforward installation thanks to low weight of the combined engineering chamber modules and variable upper sections for adaptation to the ground level
- Simple conversion to Staufix SWA, Staufix FKA or Pumpfix F

Description

The backwater technical module is equipped with an integrated clean out Controlfix and access steps.

Thanks to the modular KESSEL system, the clean out can easily be converted to a Staufix SWA Premium backwater valve, Staufix FKA or Pumpfix F backwater pumping station.

Type of wastewater:	wastewater with sewage
Installation situation:	underground installation
Delivery state:	Installation-ready (connection parts must be connected on site)

General characteristics:

Colour:	black
Approval:	Z-42.1-527

Dimensions:

Width: 1,200 mm
Height: 520 mm

Tank:

Number of inlets: 1 ST
Inlet nominal size (DN): 125
Number of outlets: 1 ST
Outlet nominal size (DN): 125
Distance from centre of outlet pipe to tank bottom: 267 mm
Distance from centre of inlet pipe to tank bottom: 277 mm
Tank width max.: 1,390 mm
Channel: continuous channel
Groundwater resistant from lower edge of base section: 3,000 mm
Clear width of tank (LW): 1,000 mm
Chamber system: modular chamber

Vertical drop between inlet and outlet: 9 mm