

Backwater lifting station Ecolift XL Mono, 1 motor-driven flap, SPF 3000-S3

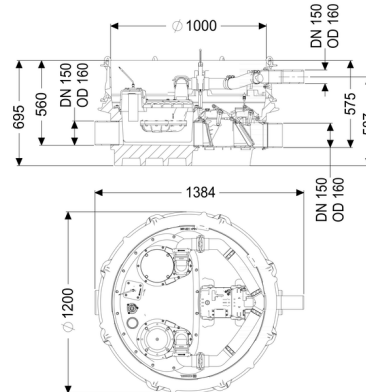

Article information

Item no.: 8741008
GTIN: 4026092068250
Price group: 60

Advantages

- Wastewater drainage without interruption, even if a power failure occurs
- Low pump use
- minimised noise emissions
- ensures low power consumption
- Reduced maintenance costs due to longer maintenance intervals in commercial/industrial use

Description

The backwater lifting station for non-faecal wastewater is equipped with one submersible pump, one motor-driven and one mechanical closure system and a backflow preventer. The collection tank made of permanently resistant polymer (PE) has an enclosed pump tank. Quick-release closures enable the integrated components to be removed easily.

Normally, draining takes place via the natural fall to the sewer. Backwater is detected by an optical probe, which causes the motor-driven closure system to close automatically and there is no longer free passage to the sewer. During the backwater phase, the water drains via a pressure pipe, which carries the wastewater into the sewer.

The pressure pipe is a welded PE pipe; with pump SPF 4500, the pressure pipe must also be continued up to a pressure release chamber.

The station is controlled by a user-friendly control unit, which is optionally integrated in the building management system via a potential-free contact, or alarm and collective fault messages can be output via a GSM interface.

The KESSEL modular system provides different upper sections and engineering chamber options as accessories.

Type of wastewater: wastewater without sewage
Installation situation: free-standing set-up, underground installation, floor slab installation

Version:

Type of system: Single station
Shut-off valve: Shut-off valve made of polymer
Pump control: Control unit
Backflow preventer: integrated
Note on installation depth: Version for deeper installation, in combination with a chamber module
Passage seal for ventilation pipe (DN): 70 mm
Passage seal for conduit pipe (DN): 100 mm
Delivery state: Pre-mounted for final assembly on site (pumps and sensor system must be fitted on site and control unit must be connected)
Backwater protection: Type 3
Number of mechanical backwater flaps: 1
Number of motor-driven backwater flaps: 1

General characteristics:

Colour: black
Approval: Z-53.2-493

Dimensions:

Length: 1,245 mm
Width: 1,200 mm
Height: 657 mm

Tank:

Number of inlets: 1 ST
Inlet nominal size (DN): 150
Number of outlets: 1 ST
Outlet nominal size (DN): 150
Distance pipe bottom inlet to tank bottom: 135 mm
Distance pipe bottom outlet to tank bottom: 120 mm
Tank volume: 65 l
Pumping volume: 20 l
Pressure pipe connection: horizontal

Pressure pipe connection (DN):	80 mm
Pressure pipe connection (OD):	90 mm
Venting connection (DN):	70 mm
Channel:	continuous channel
Groundwater resistant from lower edge of base section:	3,000 mm
Clear width of tank (LW):	1,000 mm
Nominal pressure (PN):	10
Free passage:	40 mm

Pumping device:

Pump:	SPF 3000
Number of pumps:	1
Max. pumping capacity:	36 m ³ /h
Max. pumping height:	17.5 m
Operating mode:	S3 - 50 %
Power P1:	3.2 kW
Power P2:	2.7 kW
Speed:	2,845 U/min
Type of fuse required (electrical protection):	3 x C 16 A
Max. temperature (permanent) of conveyed material:	40 °C
Connection type:	Direct connection
Weight:	24 kg
Impeller type:	Multi-vane impeller
Length of mains cable for pump:	10 m
Rated current:	5.4 A
Protection class (pump):	IP 68 (3m/48h)
Protection class:	I
Type of pump connection cable:	H07RN-F 7G 1.5 mm ²
Temperature monitoring:	integrated
Cos phi - power factor:	0.89
Insulation class:	F
Vertical drop between inlet and outlet:	15 mm

Control:

Control unit:	Comfort Plus
Operating voltage:	400 V
Mains frequency:	50 Hz
Self-diagnosis system (SDS):	yes
Battery buffering:	yes
Multi-line display:	yes
Log book function:	yes
USB interface:	yes
GSM interface:	yes

Potential-free contact:	yes
Motor protection switch:	yes
Standby power:	5 W
Protection class control unit:	IP 54
Length of mains cable for control unit:	0 m
Type of level measurement:	pneumatic
Level measurement instrument:	Immersion pipe
Alarm sensor:	optical probe