

Pumping station Aquapump F XL Tronic, SPF 4500-S3

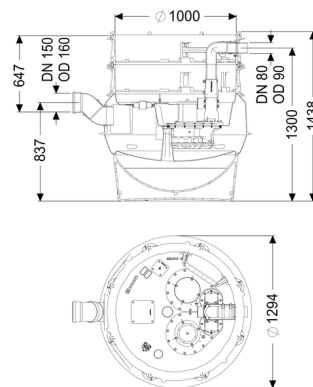

Article information

Item no.: 8742003
 GTIN: 4026092068588
 Price group: 60

Advantages

- Maximum safety
- Flexible installation
- Hygienic advantages for maintenance and repair

Description

The pumping station for faecal and faecal-free wastewater is equipped with a submersible pump, a backflow preventer and a shut-off valve for the pressure pipe. The collection tank made of permanently resistant polymer (PE) has a closed pump tank (dry installation) with a screwed-on access cover.

The station is controlled by a user-friendly control unit, which is optionally integrated in the building management system via a potential-free contact. Alternatively, alarm and collective fault messages can be output via a GSM interface.

The KESSEL modular system provides different upper sections and engineering chamber options as accessories.

Type of wastewater:	wastewater with sewage
Installation situation:	underground installation, floor slab installation

Version:

Type of system:	Single station
Installation:	Dry installation
Shut-off valve:	Shut-off valve made of polymer
Pump control:	Control unit
Backflow preventer:	integrated
Access steps:	yes

Note on installation depth: Version for deeper installation, in combination with a chamber module

Delivery state: Pre-mounted for final assembly on site (pumps and sensor system must be fitted on site and control unit must be connected)

General characteristics:

Colour: black
Standard: EN 12050-1

Dimensions:

Length: 1,295 mm
Width: 1,295 mm
Height: 1,403 mm

Tank:

Number of inlets: 1 ST
Inlet nominal size (DN): 150
Inlet nominal size (OD): 160 mm
Distance pipe bottom inlet to tank bottom: 753 mm
Distance from centre of outlet pipe to tank bottom: 1,300 mm
Distance from centre of inlet pipe to tank bottom: 833 mm
Tank volume: 335 l
Pumping volume: 160 l
Pressure pipe connection: horizontal
Pressure pipe connection (DN): 80 mm
Pressure pipe connection (OD): 90 mm
Venting connection (DN): 70 mm
Groundwater resistant from lower edge of base section: 3,000 mm
Clear width of tank (LW): 1,000 mm
Free passage: 40 mm

Pumping device:

Pump: SPF 4500
Number of pumps: 1
Max. pumping capacity: 55 m³/h
Max. pumping height: 20 m
Operating mode: S3 - 50 %

Power P1:	4.2 kW
Power P2:	3.5 kW
Speed:	2,850 U/min
Max. temperature (permanent) of conveyed material:	40 °C
Connection type:	Direct connection
Weight:	26 kg
Impeller type:	Multi-vane impeller
Length of mains cable for pump:	10 m
Rated current:	7.5 A
Protection class (pump):	IP 68 (3m/48h)
Protection class:	I
Type of pump connection cable:	H07RN-F 7G 1.5 mm ²
Temperature monitoring:	integrated
Cos phi - power factor:	0.85
Insulation class:	F

Control:

Control unit:	Comfort
Operating voltage:	400 V
Mains frequency:	50 Hz
Self-diagnosis system (SDS):	yes
Battery buffering:	yes
Multi-line display:	yes
Log book function:	yes
GSM interface:	yes
Potential-free contact:	yes
Type of fuse required (electrical protection):	3 x C 16 A
Motor protection switch:	yes
Protection class control unit:	IP 54
Length of mains cable for control unit:	0 m
Type of level measurement:	pneumatic
Level measurement instrument:	Immersion pipe
Alarm sensor:	Immersion pipe